

# 2020 PTV School Student ID and Student Pass application form\*

## Applicant details

First name

Last name

Address (please leave a gap between numbers and words)



State

Postcode

Phone number

## School declaration

I confirm the details of the student named in this application form are correct. I've checked the student's school records and the student is full-time and eligible for a PTV School Student ID. I agree that this school will let PTV know if these details change.

Signature of Principal, Bursar, Registrar or Secretary

Date

Name of signatory

School Name

School telephone number

Official school stamp

\*A \$9 application fee applies.

## Please attach photos here

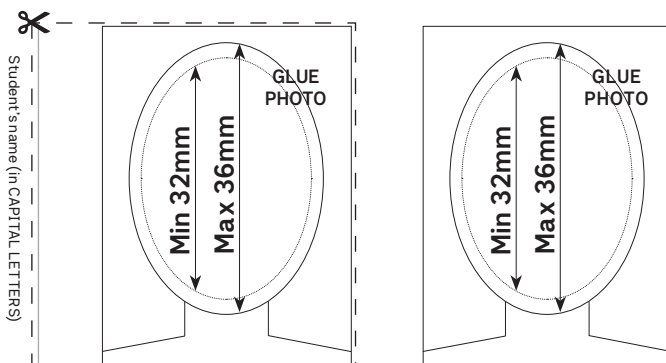

- Photos must be passport style and include head and shoulders. School photos or photos taken using a smartphone against a white background may be used
- Make sure they're colour, in focus and identical
- Don't use sticky tape
- Stamp the photos with your official stamp. Stamp the top left hand corner, not over the face.

Locations of issue: Metropolitan Premium Stations, staffed V/Line Stations, PTV Hubs, regional bus operators & V/Line ticket agents. Call 1800 800 007 for locations and hours of operation or visit [ptv.vic.gov.au](http://ptv.vic.gov.au)

Some stations may not be able to process forms before 9.30am and between 3.30pm to 6.00pm on weekdays.

File Number

